

COVERS ALL YOUR NEEDS

AGRICULTURE



A WIDE PRODUCT RANGE FOR EVERY APPLICATIONS

HAY AND STRAW



MATERIAL



CEREALS



BIG-BAGS



BULK STORAGE



FIREWOOD



CATTLE BREEDING



SHEEPFOLD



EQUESTRIAN



The Shelterall® may require prior approval or a construction permit before assembly: The buyer is required to check with the relevant town planning authorities.

Optimised volumes

Width varying from 14' 9" to 82'. The bend of the Shelterall® arches provides an easy movement around the sides.

Adaptable

Shelterall® is quick to assemble and dismantle thanks to its assembly system. The simple arch range is designed for an anchoring system without foundation.

SIMPLE ARCH

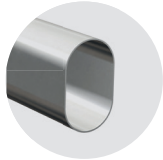

OV90

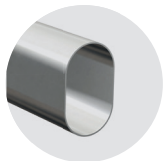
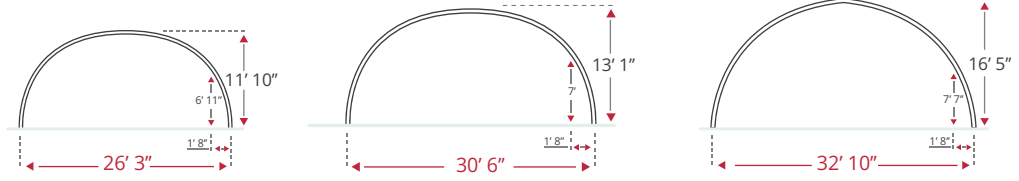

OV130

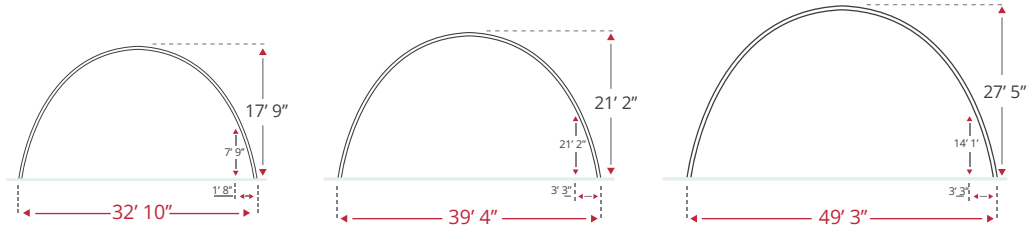

TRUSS ARCH

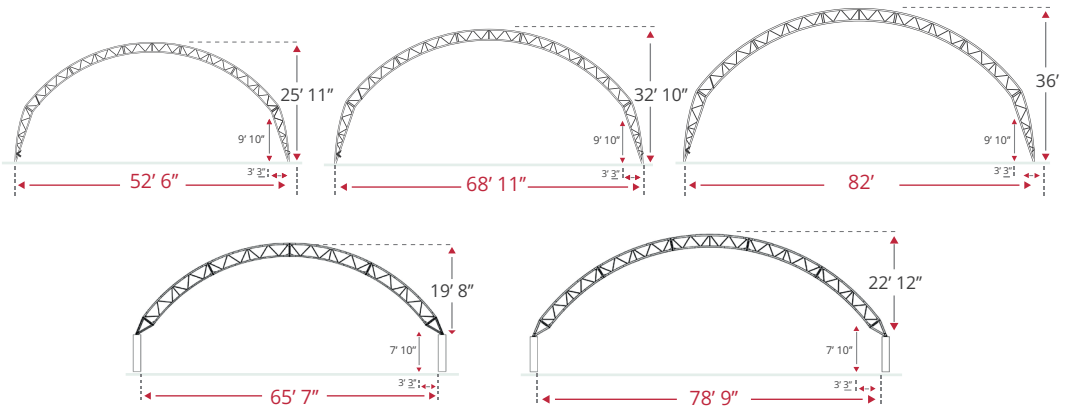

Colours cover:



Beige



Green/White



Grey/White

CUSTOM MADE OPTIONS

GABLES

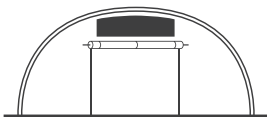

Gable and Roll up door

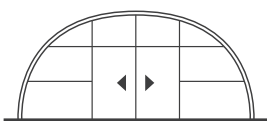

Solid gable and double sliding door

SIDE PROTECTION STEEL SHEETING

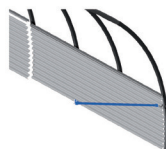

INSULATION

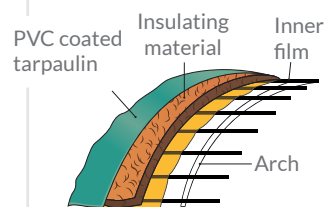

ANCHORING

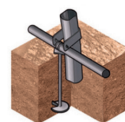

Screw-in anchor

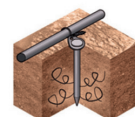

Hook anchor

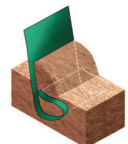

Buried tarpaulin



Anchoring bolt

RICHEL TECHNOLOGY

The Shelterall® benefits from the technology and reliability of the Richel Group, the number one greenhouse manufacturer in Europe. Its design and manufacture are SOCOTEC approved. Its galvanised steel frame (as per the NF N 10346 Sendzimir method) complies with the European standard NF EN 13031-1. Its PVC coated tarpaulin benefits from 10-year warranty*.

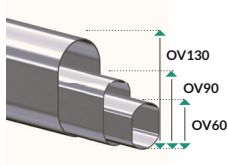

Evolution of sections of ovalized profiles

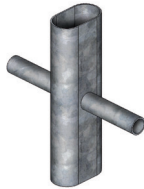

The weld-free cross assembly, patented by Richel (patent No. 2954960).

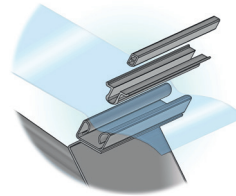

Richel clips to attach the tarpaulin and keep it tightly drawn.

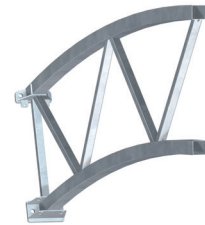

The truss arch enlarge the span width by optimizing material. The best technical choice for spans greater than 15m.

*See general sales conditions



INDUSTRIAL PRODUCTION SITE, EYGALIÈRES FRANCE

RICHEL GROUP® designs, manufactures and develops complete greenhouse and shelter solutions for agriculture, construction and industry all over the worldIts industrial.

Its expertise has enabled it to develop for 20 years in other activities that have become essential for the group, such as storage solutions represented by the SHELTERALL® (storage shelters) and TOUTABLOC® (concrete block walls and huts brands).

www.shelterall.eu



Quartier de la Gare - 13810 Eygalieres - France
Tel.: +33 (0)4 90 95 14 68
E-Mail: shelterall@richel.fr
www.shelterall.eu

Our distributor: